

YUME DX

Operating Instructions



Thank you for purchasing our Takara Belmont YUME DX.

The instructions contained in this booklet should be thoroughly read and understood before operating the shampoo unit.

This product is intended for the exclusive use for hairdressing & barber salons, and must not be used for other purpose.

Keep manual in a place where it can be easily referred to when necessary.

Thank you for purchasing our product.

Please read through this manual and this note carefully before installing or using.

These instructions provide important information for correct usage of the product to avoid personal injuries or property damages against you or your clients.

This product is intended for the exclusive use in hair salon or esthetic salon for their treatment and service, and must be operated or handled by the qualified/professional hairdressers or by their staff under the supervision of hairdressers.

**TAKARA
BELMONT**

1A0FTXA0

Version 5

2019.02

TABLE OF CONTENTS

1. Locations of Warning Labels	1
2. Dimension and Specifications.....	2
3. Overall View and Major Components.....	3
4. Accessories.....	4
5. Preparation	4
6. Operating Instruction.....	5
7. Maintenance.....	8
8. Troubleshooting.....	10
9. Consumable Parts.....	10

1. Locations of Warning Labels

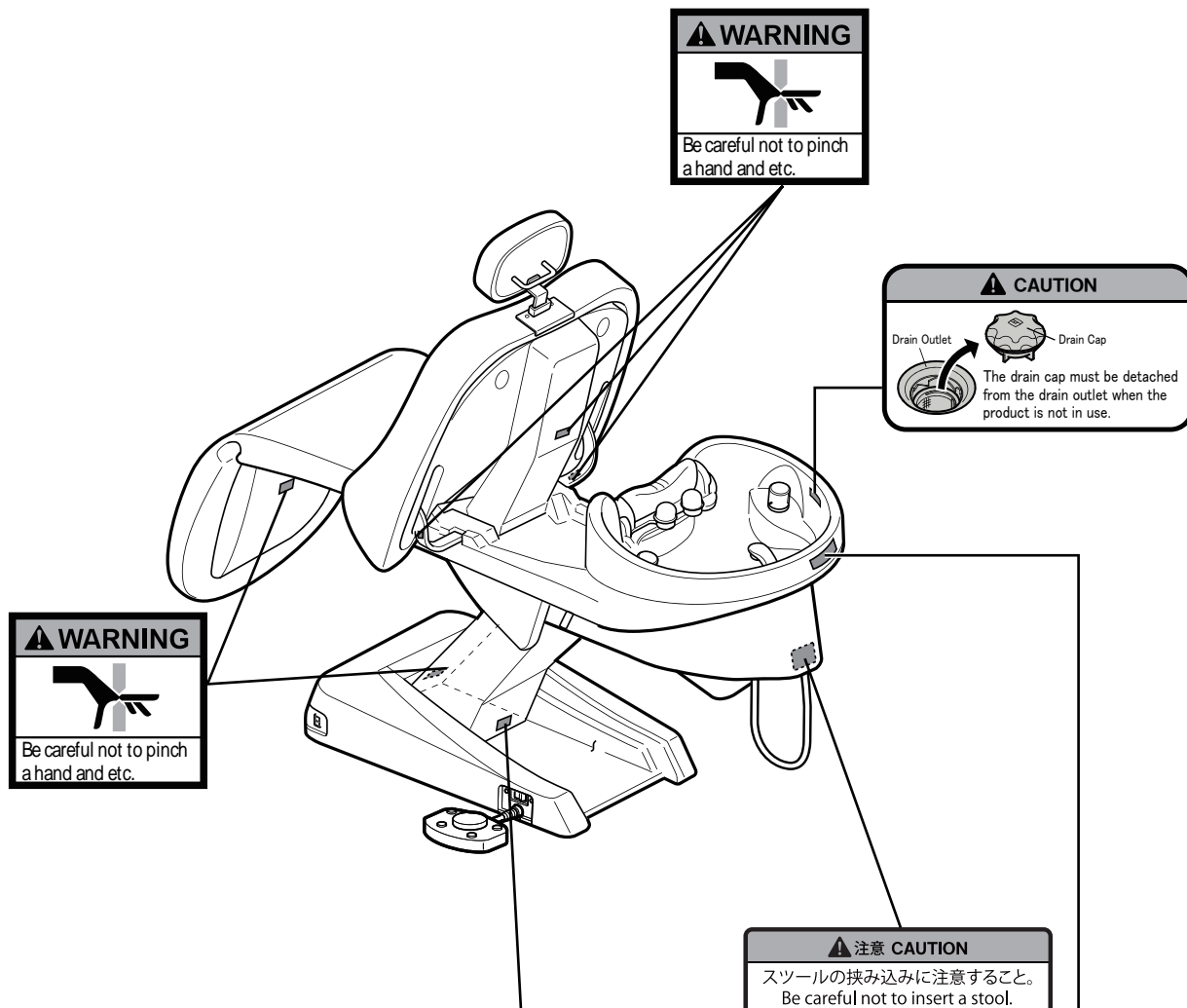



⚠ WARNING

 Be careful not to pinch a hand and etc.

⚠ CAUTION

 The drain cap must be detached from the drain outlet when the product is not in use.

⚠ 注意 CAUTION
 スツールの挟み込みに注意すること。
 Be careful not to insert a stool.

⚠ WARNING	⚠ WARNING	⚠ WARNING	⚠ WARNING
Risk of Pinching KEEP OFF hands or obstacles when adjusting angle.	Risk of Electric Leakage. DO NOT drench the unit.	Disconnect power supply plug when unit is not in use.	Risk of Electric Shock and malfunction. DO NOT disassemble, repair or modify.
Please read the Operating Manual carefully for other safety cautions.			

⚠ CAUTION	⚠ CAUTION	⚠ CAUTION
		
Do not use hot water of 60°C and higher. Using hot water at 60°C and higher may deform or damage the ceramic bowl, the shower head or the faucet handle.	If chemical such as hair dye attached to the equipment, wipe it out immediately, or it may cause discoloration or deterioration.	Do not use chemical detergent mainly containing caustic soda (NaOH) & caustic potash (KOH) for cleaning drain pipes, etc. This may cause damage on the drain hose, etc.
For other cautions, please read the operating instruction carefully before use.		

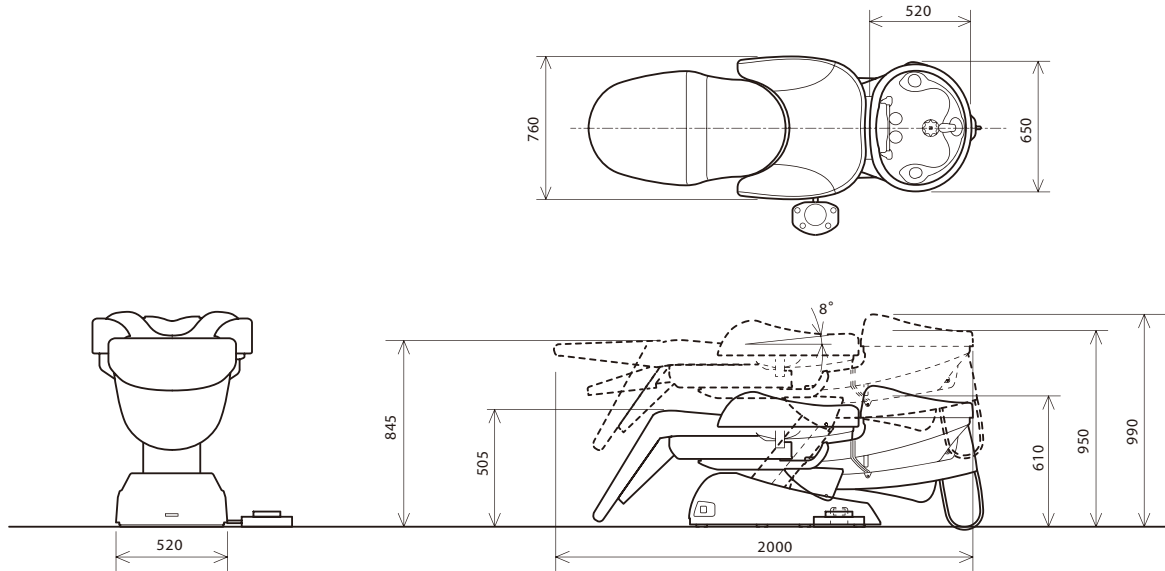
2. Dimension and Specifications



Type	EX-YM2NL, EX-YM2NR, SU-YM2
Drive System	Motorized Hydraulic System
Measurement	760 x 2000 x 990 mm (W x L x H)
Angle of Backrest	67° (8° ~ 75°)
Type of Mixing	Thermo Mixing
Stop Valve	Water x 1 (Handle Type) / Hot Water x 1 (Handle Type)
Electrical Requirements	220V 50Hz 1.7A
Electrical Requirements	230V 50Hz 1.7A (appliance itself)(CE Spec,)
Usage Environment	Operational Temperature (10 ~ 40°C)
Water and Hot Water	0.08 ~ 0.6Mpa (0.8 ~ 6kgf/cm ²)
Supply Pressure	Water Supply Pressure ≥ Hot Water Supply Pressure Pressure difference between water supply and hot water supply within 0.2Mpa (2kgf.cm ²)
Water Volume (Shower Head)	10L /min (water and hot water pressure are 0.1 Mpa)
Weight	205 kg

3. Overall View and Major Components

■ Main Body

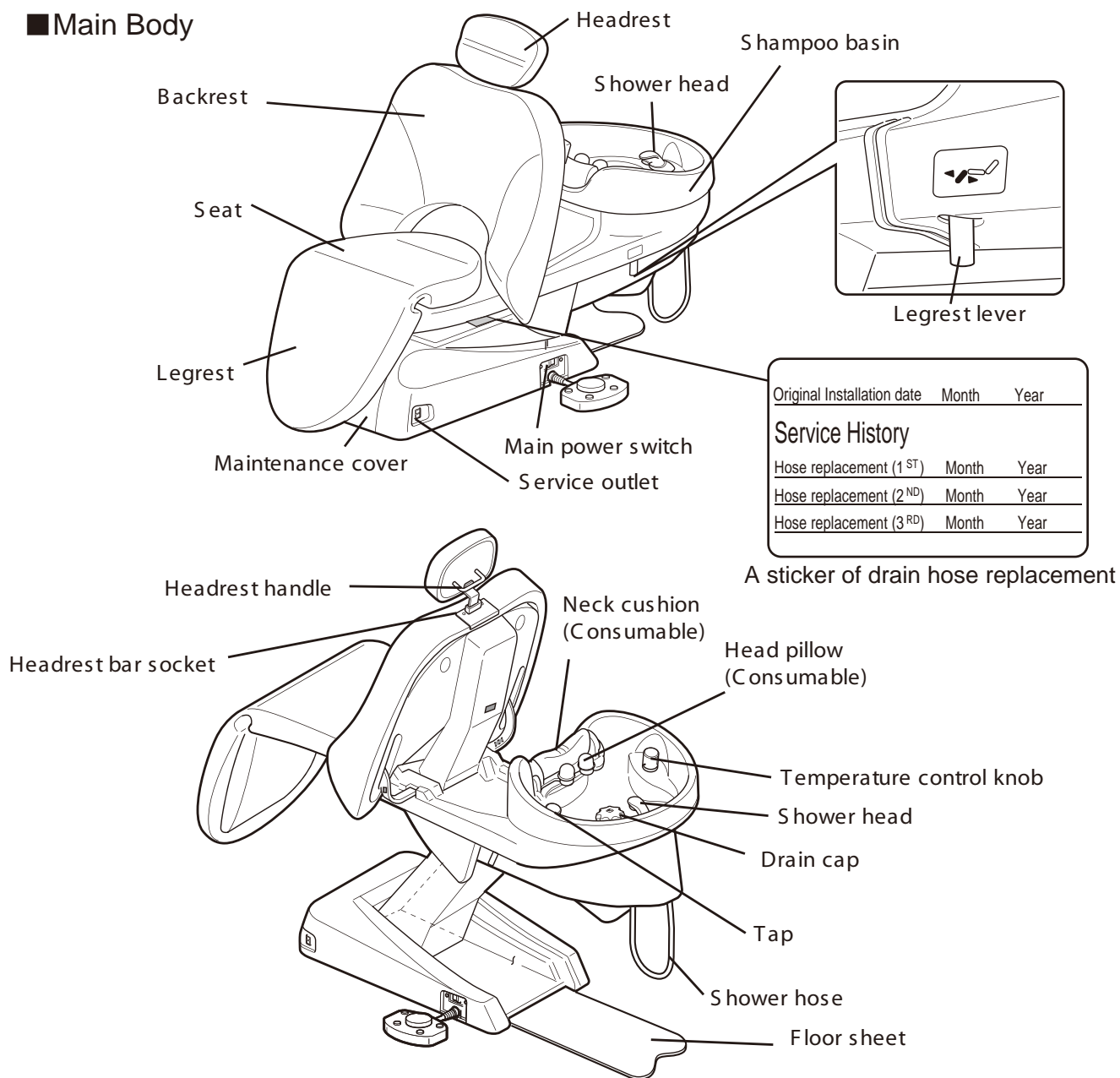

■ Foot Switch

EX-YM2NLA : Left side foot switch

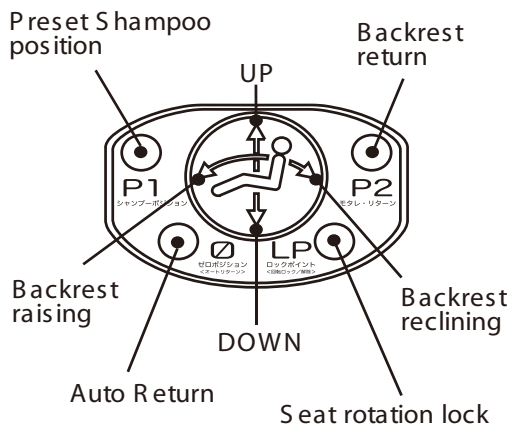

EX-YM2NRA : Right side foot switch

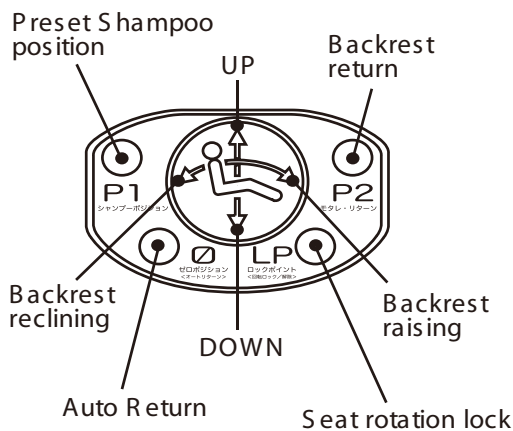

■ Leg-rest Lever

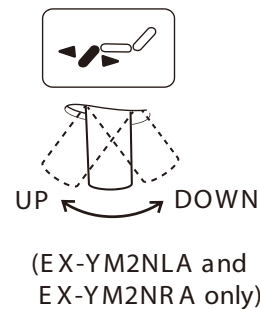

4. Accessories

Neck Cushion ...1

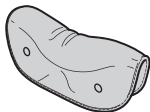

Head Pillow ...1set

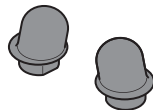

Noise Reduction Tape ...1

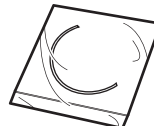

Drain Cap ...1

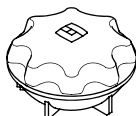

Hair Catcher ...1



Anti-water dropping device ...1

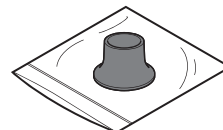

Operation Manual ...1

Installation instructions ...1

YUME SPA Technical Manual ...1

5. Preparation

5-1. Attach the Neck Cushion

1. Attach the neck cushion on metal fittings as shown in figure.

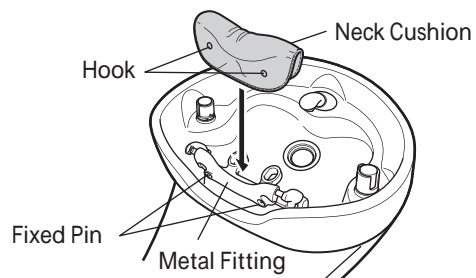

2. Both side hooks of the neck cushion is fixed on a fixed pin.

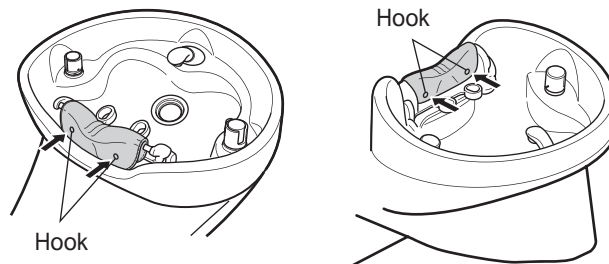

5-2. Attach the Head Pillow

1. Attach the head pillow as shown in figure

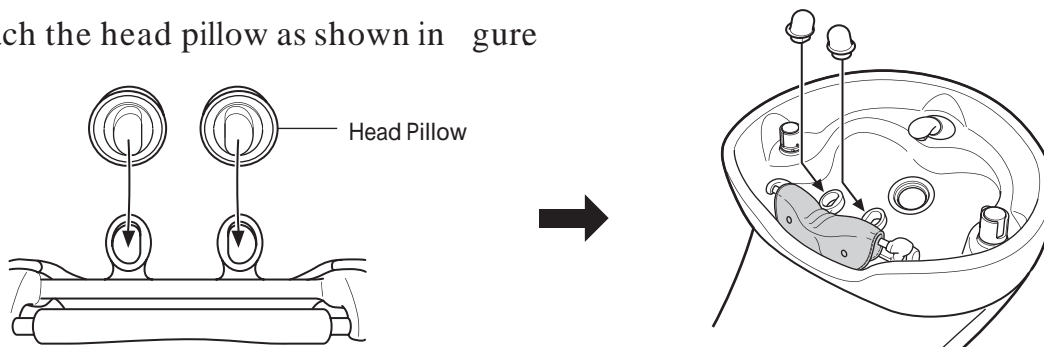

6. Operating Instruction

6-1 Main Switch

Main switch is located on the left side of the pump cover (EX-Y M2NL) or on the right side (EX-Y M2NR).

⚠ Caution

Turn off the main switch after daily operation
Operate the main switch by hand only.
In the event of extremely low oil temperature,
“warm-up” mode may start.

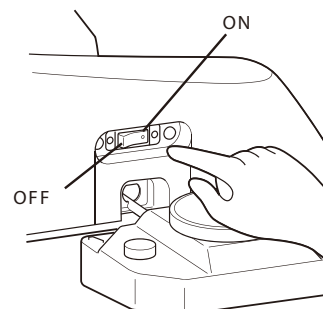

<Warm-up mode>

Warm-up operation goes on at the extremely low oil temperature. It beeps for 3 minutes until this mode completes.

6-2 Controls

Before operating the chair, confirm that it is safe for the patient and the operator.

(1) Manual Mode Control

A. Seat Lifting

Keep depressing UP button until the seat is lifted up to the desired position.

B. Seat Lowering

Keep depressing DOWN button until the seat is lowered to the desired position.

C. Backrest Reclining

Keep depressing Backrest reclining button until the backrest is reclined to the desired position.

D. Backrest Raising

Keep depressing Backrest raising button until the backrest is raised to the desired position.

E. Legrest Raising (EX-Y M2NLA and EX-Y M2NRA only)

Move leg-rest lever to the left/right side for up-and-down.

F. Seat Rotating

Make sure to raise the backrest by depressing P2 button rotating the seat. Momentarily press LP button (Lock button) releases the safety seat lock.

*The lock is not released when backrest angle is less than 30°.

Rotating the seat slowly by holding the backrest.

Press LP button again to lock the seat at desired position.

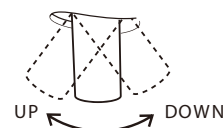
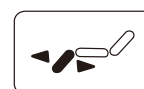
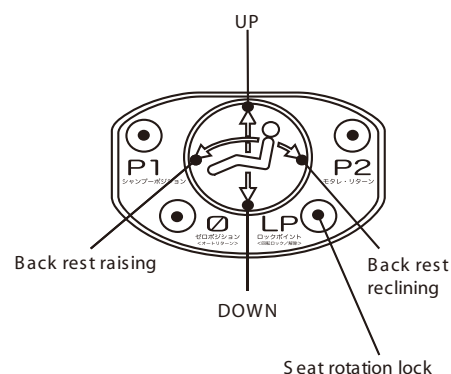

(2) Auto Mode Control

G. Preset Control

Press P1 button a little longer (for around half second), the seat will move to the preset shampoo position automatically. (If adjustment is needed, please refer AUTO MODE POSITION ADJUSTMENT.)

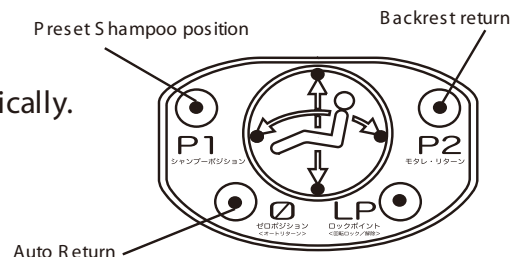

H. Auto Return

Press P2 button a bit longer (for around half second) puts the backrest upright position automatically. Press Auto Return button for around half second, the seat will return to the initial position.

* Initial position : seat - lowest point , backrest - upright position

I. Emergency Stop

During automatic procedure (Preset and Auto return), depress of any side of the buttons on the foot control will cancel the automatic movement immediately.

6-3 Auto Mode Position Adjustment

Preset position adjustment

- A. Set the seat and the backrest to the desired preset position by manual control.
- B. Turn off main switch.
- C. While depressing P1 button, turn on main switch.
- D. Keep depressing P1 button until buzzer sounds, then release it.

6-4. SAFETY LOCK DEVICE

Chair down movements can be stopped automatically by the safety lock device when pressure is detected between the base and the safety lock cover.

If the safety device has been activated, simply operate the base up button and remove the object causing the safety device to activate from this area.

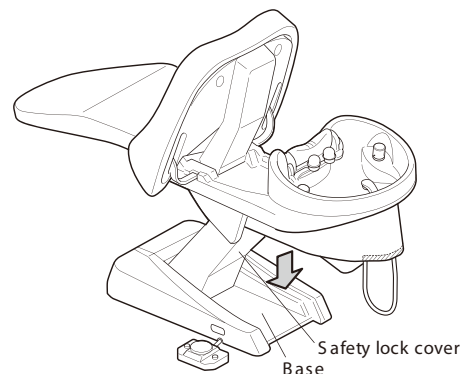

6-5 Adjustment the Water / Hot Water

- Turn the tap to counter clockwise.
- Adjust the water temperature with temperature control knob.
- Press stop button on the temperature control knob to release lock for hot water, then turn clockwise.

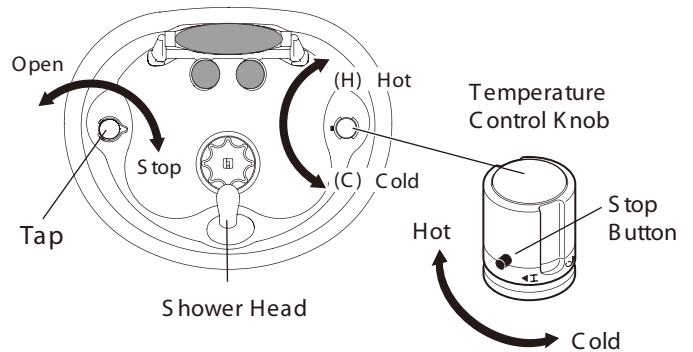

6-6 Accumulating Hot Water

Rotate the drain cap in the clockwise direction to close the drain outlet.

To drain the accumulated water, rotate the drain cap in the counterclockwise direction to open the drain outlet.

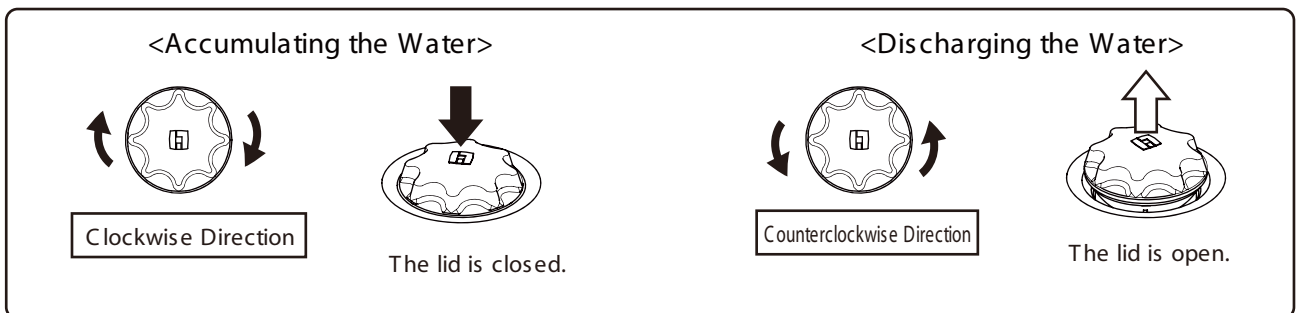
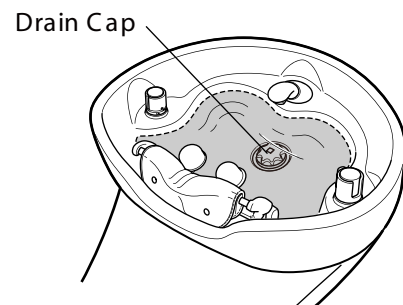

⚠ Caution

The drain cap must be detached from the drain outlet when the product is not in use. If the lid is not detached, the lid may accidentally close, and the water may overflow the basin from the failure to notice water discharge, thus resulting in water leaks.

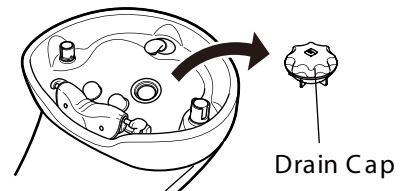

6-7 How to use Headrest (SU-Y M2A M and SU-Y M2B M only)

Headrest can be utilized in facial treatment and massage.
Set the backrest position to attach the headrest properly
Attach the headrest bar to the end tightly.

6-8 How to use Service Outlet

The unit is equipped with a service outlet on the left/right side of the pump cover.

Capacity : Up to 1,500W (the main unit is not in use)

Up to 900W (the main unit is in use)

Usage in excess of the maximum capacity switches off the main unit.

7. Maintenance

Notice

Do not use the following substances.

Thinner, alcohol, gasoline, kerosene or other volatile chemicals; waxes containing abrasives; sponges containing abrasives, etc.

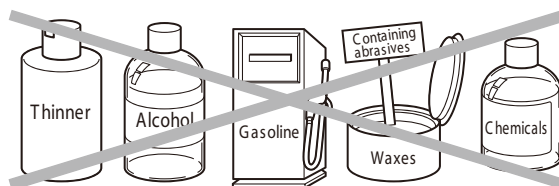

7-1. Hair Catcher

Take out the hair catcher under the drain cap and remove hairs from the hair catcher.

⚠ Caution

Clean the hair catcher as often as possible. If using the hair catcher not cleaned, it may cause clogging of the port, overflow or poor sanitary. Cleaning the hair catcher every after each shampooing is recommended.



7-2. Neck cushion and head pillow(consumable parts)

Use dry cloth to wipe off water and dry in shade.

Dump cloth with neutral detergent and wipe to remove coloring or perm solution.

⚠ Caution

Rinse the cushion immediately after chemical is splashed on the neck cushion. Splashed chemical may cause deterioration or discoloration.

7-3. Use dry and soft cloth to clean upholstery, plastics, plated and painted surface.

Dump cloth with neutral detergent and wipe to remove stubborn stains and dirt. Use only mild neutral detergent. Use cotton buds etc. to clean around the neck cushion and head pillow mounting parts.

7-4. Drain cap

Wash around the drain cap, and remove any hair or dirt from solvents.

The drain cap is a consumable supply.

If it is extremely dirty, remove the packing from the drain cap, wash with detergent solution diluted using water, and rinse carefully with water.

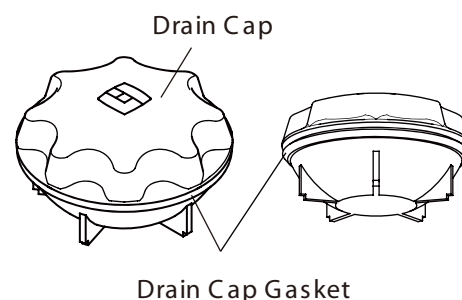

7-5. Cleaning of bowl

Wipe the bowl with diluted neutral detergent.



Do NOT use metal scrub brushes, paper files. Using them may be a cause of scars.

7-6. Strainer for check valve

Clean strainer (built-in check valve) at regular intervals.

Remove the water in strainer if freezing is expected in the cold district.

- A. Raise the chair and turn off the main switch.
- B. Remove 2 screws and open the maintenance cover
- C. Place cloths near the water / hot water supplise.

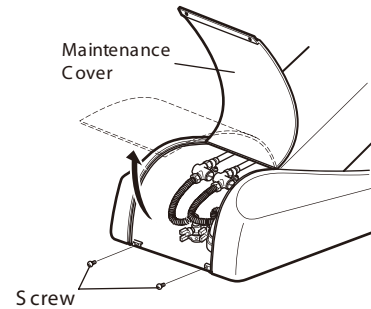

- D. Turn off the water & hot water stop valves and remove strainer by flat head screw driver and wipe off the water by cloth.

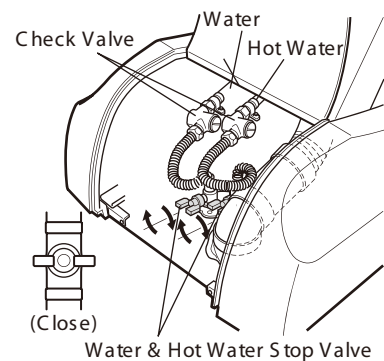

- E. After cleaning the strainer, put it back and tighten up.
- F. Wipe water off and remove cloth.

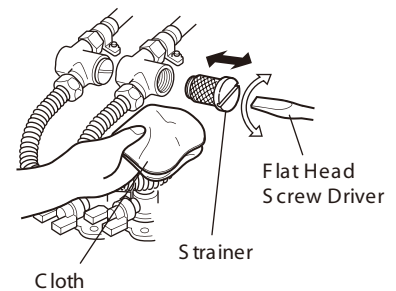

- G. Turn on the water & hot water stop valves.
- H. Close the maintenance cover and install 2 screws.

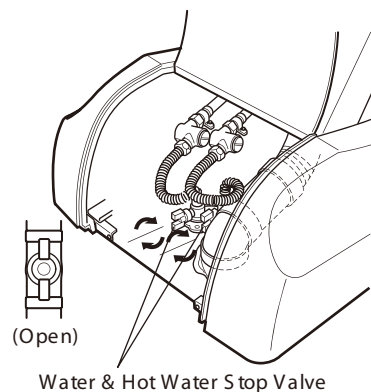

Water leak check

Open the maintenance cover and check water leakage once a week.

8. Troubleshooting

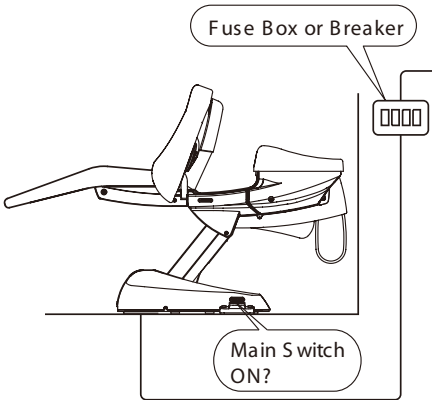
Symptom	Check
<ul style="list-style-type: none"> ● Seat and backrest doesn't move 	<ul style="list-style-type: none"> ○ Make sure that the power plug is properly plugged into the outlet. ○ Make sure that the main switch has been turned on.
	<ul style="list-style-type: none"> ○ Check the fuses in your fuse box to make sure they haven't burned out. If you have a breaker box, check for tripped breakers.
	<ul style="list-style-type: none"> ○ After the long time operation, Over temperature protection system works. Please leave the chair for 10 minutes and start operation. Unplug the machine and then plug it in again and see if it will operate.
<ul style="list-style-type: none"> ● No Water / Hot Water 	<ul style="list-style-type: none"> ○ Make sure that the water & hot water stop valve has been turned on.
<ul style="list-style-type: none"> ● The temperature of hot water is too low 	<ul style="list-style-type: none"> ○ Check to make sure that the temperature setting of water supply tank is properly. ○ Make sure that the temperature setting of the chair is properly.
<ul style="list-style-type: none"> ● Slow drainage 	<ul style="list-style-type: none"> ○ Check to make sure that the hair removed from the hair catcher completely.

In case other than those listed above, contact our service center or sales office.

CAUTION

If the supply cord is damaged, it must be replaced by the manufacturer or its service agent or similarly qualified person in order to avoid hazard.

9. Consumable Parts

- Neck cushion • Head pillows • Drain cap • Anti-water dropping device



Caution

**Be careful of use.**

Children shall not play with the appliance.

**Be careful of use.**

Cleaning and user maintenance shall not be made by children without supervision.

**Be careful of use.**

The appliance is not to be used by children or persons with reduced physical, sensory or mental capabilities, or lack of experience and knowledge, unless they have been given supervision or instruction.

NOTE

EU REPRESENTATIVE**TAKARA COMPANY EUROPE GmbH**

Berner Strasse 18, 60437
Frankfurt am Main, Germany

TEL: +49 69 506878 0
FAX: +49 69 506878 20

MANUFACTURER**TAKARA
BELMONT****TAKARA BELMONT CORPORATION**

2-1-1, Higashishinsaibashi, Chuo-ku, Osaka, 542-0083, Japan
TEL: 81-6-6212-3523
FAX: 81-6-6211-5745

