

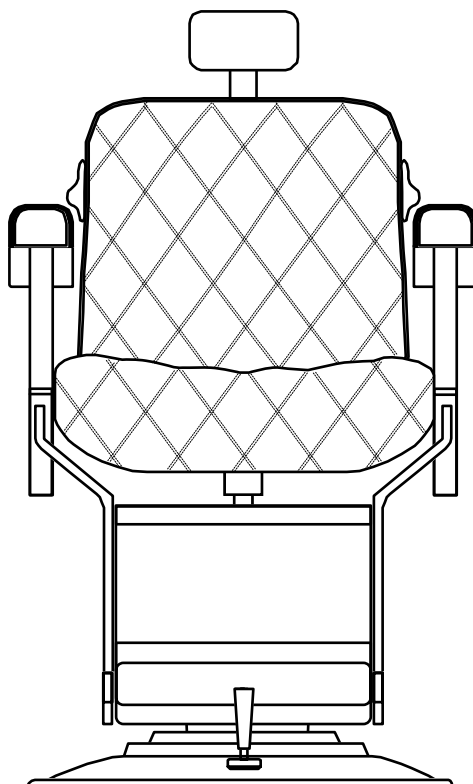

Hydraulic Chair Manual

Thank you for choosing TAKARA BELMONT equipment.

Apollo 2 Icon



Please read through this manual before assembling, installing or using the product to ensure safe and correct use. This product is designed for commercial use in hairdressing and beauty salons. Do NOT use this product for purposes other than the practices and services typically offered in these places.

Please keep this manual in a safe place for your future reference.

A PDF version of this manual can be downloaded at takarahairdressing.co.uk/downloads

ASSEMBLY AND INSTALLATION INSTRUCTIONS

Assembling the chair top with the base



- Carefully position the chair base on a flat and solid floor.
- Present the chair top to the base, line up the ditch to the pin and insert the seat flange firmly.
- Check that the chair top is attached securely.



If the chair is used without the pin inserted firmly into the ditch, the chair may become unstable resulting in damage or injury.

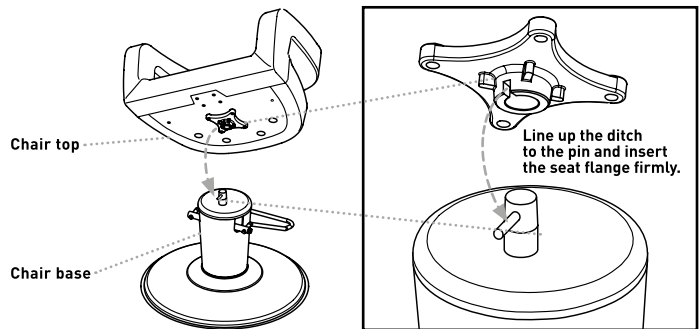

Assembling the U-shape and T-shape footrest



- When assembling the footrest, do NOT use any screws other than those provided by Takara Belmont (located on the underside of chair top).
 - Ensure all screws are tightened firmly. If the footrest is not attached to the chair firmly, it will become unstable and may result in damage or injury.
 - Take care not to damage the upholstery or the chair parts during assembly: the chair top should be kept separate from the assemblage area.
- Please note, these drawings are for illustrative purposes only.

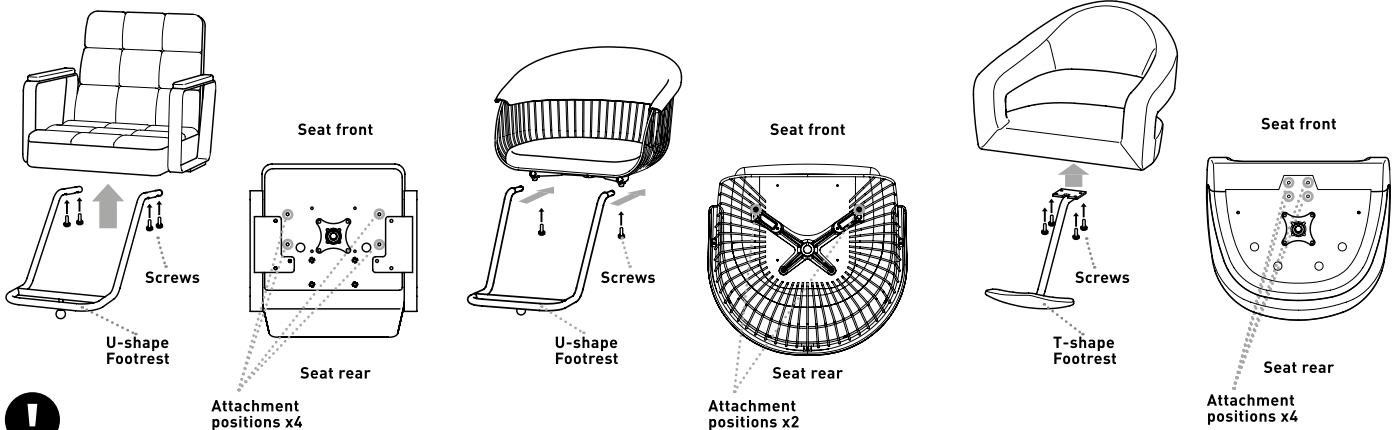

1. Locate and remove the attached screws from the underside of the chair top →
2. Attach the footrest to the position where the screws were attached →
3. Tighten firmly →
4. Check that the footrest is attached securely.

Safety precautions during installation



The chair must be installed on a flat and solid floor to ensure its stability.

At least two people should assist with carrying or moving a chair at all times.

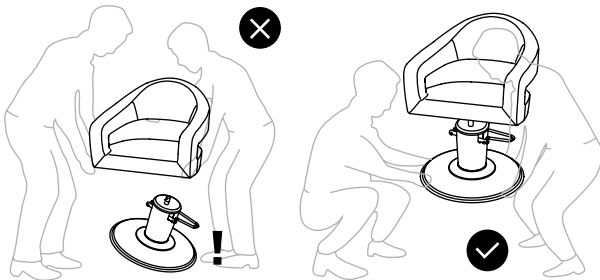

- Do NOT apply any weight or stress to the armrest while carrying or moving the chair to avoid breakage or deformation to the armrests.
- Do NOT hold and move the chair with somebody or something in the seat.



- Take care when touching the underside of the chair top. Parts such as fixing screws, fasteners, metal parts are attached here and careless contact may result in injury.
- Carrying the chair by gripping the chair top is likely to cause the chair base to slip off and may result in serious injury.



1. Lock the chair using the foot pedal before lifting →
2. Carry the chair by holding it beneath the base →
3. Place the chair down gently, being careful not to mark the floor →
4. Lift the chair carefully into its final position.

Hydraulic base operation

! Operate the foot pedal with appropriate force. Observe the safety precautions shown below.

Adjusting the height

To avoid damage or injury, please observe the following advice:

- Before raising or lowering the chair, ensure that there are no people or objects obstructing the chair, foot pedal or footrest.

RAISE
Pump gently to raise the seat



LOWER
Gently press down and hold to lower the seat



LOCK
Gently press upwards and hold, to lock the chair in place

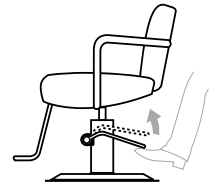

Rotating the chair

To avoid damage or injury, please observe the following advice:

- Before rotating the chair, ensure that there are no people or objects including cables obstructing the chair, foot pedal or footrest.

UNLOCK
Gently press down to unlock

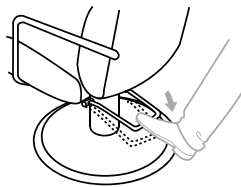

ROTATE
Swivel the chair carefully with two hands



LOCK
Gently press upwards and hold, to lock the chair rotation

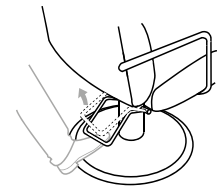

Safety precautions during operation

These precautions are provided for the safe use of this product and to prevent personal injury to users.

! Do NOT lean on the chair carelessly, climb on the seat, or sit on the armrest to avoid unbalancing or unintentionally rotating the chair, resulting in damage or injury.

! For ease and comfort, ensure that your customers enter and exit the chair at its lowest position. For comfort and stability while seated, recommend your customers to keep their feet on the footrest.

Entering and exiting the chair

⊘ To avoid toppling the chair resulting in damage or injury, please observe the following advice:

- Do NOT apply a load of 30kg or over to the tip of the footrest and do NOT jump on the footrest even if the load is less than 30kg.
- Do NOT step on the tip of the footrest.
- Do NOT enter or exit the chair by stepping on the footrest.

! To avoid customer injury as a result of chair use, please observe the following advice:

- Pay attention to the chair base when entering and exiting the chair to avoid tumbling which may result in injury.
- Take care that your customer's exit is not obstructed by the foot pedal or footrest to avoid tumbling which may result in injury.

! To avoid damage or injury from accessories such as hairdryers, please observe the following advice:

- Take care NOT to hook or tangle any cables around the underside of the chair top, armrests or backrest.

Raising, lowering and rotating the chair

! To avoid damage or injury, please observe the following advice:

- Before raising or lowering the chair, ensure that there are no people or objects obstructing the chair, foot pedal or footrest.
- Before rotating the chair, ensure that there are no people or objects including cables obstructing the chair, foot pedal or footrest.
- Before rotating the chair, ensure that the customer's feet are not going to be pinched between the footrest and the foot pedal. Advise your customer to place their feet on the footrest securely.
- Operate the foot pedal with appropriate force to avoid hitting the backrest with your knee.

Symbols key:



WARNING



CAUTION



ATTENTION



PROHIBITED

Upholstery Care

The following guidance applies to both synthetic and natural leather upholsteries.

Adherence of fabric dyes:

The upholstery may be stained by coming into contact with fabric, belts or other such attire. In order to avoid infiltration by plasticiser when colour has been adhered, apply a solution of neutral detergent diluted by about 10% to a soft towel and wipe off the colour as soon as possible. After wiping off the colour, wipe the area dry.

Colour deterioration and staining caused by contact:

- Contact with things such as other plastic parts, paints, solvents, and adhesive tape may cause changes to the surface shine, cracking, deformation, or peeling.
- Contact with newspaper or printed materials may cause colour staining.
- Contact with liquids such as benzene, nail polish remover, or alcohol may cause the surface to discolour, dissolve, harden, soften, peel, extract plasticiser, or experience changes to its shine.
- Using bleach or sheets that use bleach may cause discolouration or changes to shine.
- Keep all sharp objects away from the upholstery.
- When placed next to a source of excessive heat such as an iron or heater, deformation or discolouration may occur.
- Shield the upholstery with a curtain or other such item so that it does not come into contact with direct sunlight. Otherwise, surface changes, shrinkage, discolouration, or fading may occur.
- Heavy objects placed on the upholstery for long periods of time may leave an impression and wrinkles that may be permanent.

Wrinkles and/or surface waviness may exist in the chair's upholstery or occur over time:

The product uses soft cushion materials and considered fabrics for comfort and durability. Fabrics possess characteristic marks which exist by design and not by fault. Furthermore, additional wrinkles and surface waviness may develop depending on the demands and conditions of use.

Notes

Please observe the following.

The standard period of use for this product is seven years:

The 'standard period of use' is a guide to a standard period of time that the product can be expected to perform under normal salon conditions, assuming regular inspections and any appropriate maintenance (including parts replacement) has been performed during this period. Note: this is not a warranty period.

- ###
- No parts are specified as "consumable" for this product.
 - Scratches, dirt, deterioration and corrosion of the exterior parts stated below are not covered by warranty:
 - upholstery including the vinyl, cushioning, threads, etc.
 - all other exterior parts

Daily Maintenance



- Do NOT use leather cleaner containing solvents or abrasives. The surface may degrade, leading to changes in the texture and luster.
- Do NOT use volatile chemicals such as thinners, alcohol, benzene, nail polish remover, gasoline or kerosene, abrasive wax, abrasive sponges and so on.
- Do NOT use brushes or scouring pads.
- Make sure that cleaning utensils do NOT contact the product during general cleaning. Neglecting this caution may result in deterioration or breakage of the product.

Daily Inspections

The following inspections should be carried out every day to ensure safety during use and the longevity of the equipment:

Inspect	Test method	Defective results
Stability of chair and base →	Gently push or shake the top of the backrest in all directions, observing any instability →	If you find the chair to be unstable, do NOT use it. Contact your dealer or Takara Belmont for advice.
Moving and lockable parts →	Use the foot pedal to adjust the chair height, checking that the chair stops and locks at the desired position without sinking down →	If the chair does not stop at the desired position, do NOT use it. Contact your dealer or Takara Belmont for advice.
Function without obstruction →	Check that the chair does not produce abnormal sounds during rotation and height-adjustment →	If the chair produces abnormal sounds, do NOT use it. Contact your dealer or Takara Belmont for advice.

Maintenance service parts and replacement parts:

We hold parts for the product for seven years after the discontinuation of the product. Note: the maintenance service parts refer to the parts that are required for repairing or restoring the product's physical integrity or functions to the intended optimum condition.

Disposing of the product:

When the product or the replaced parts are to be disposed of, treat them appropriately according to the laws and regulations pertaining to proper disposal in your country.